

SOUTHWEST

TENNESSEE COMMUNITY COLLEGE

Meeting Room Setups

Please circle one of the following setups for your event or supply a specific diagram of your setup.
Southwest Tennessee Community College will set up for events only once.

Conference Style

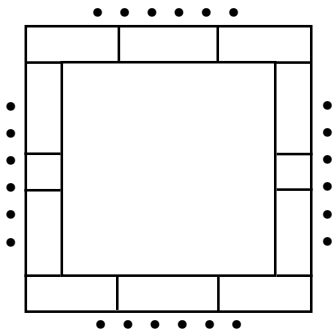

Hollow Square
1

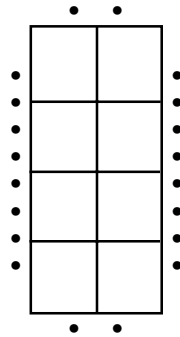

Board Room
2

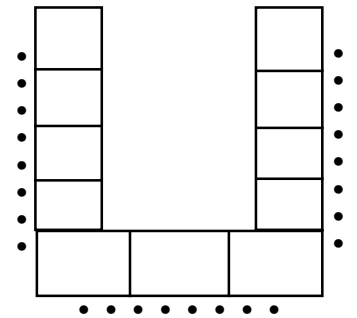

Horseshoe
3

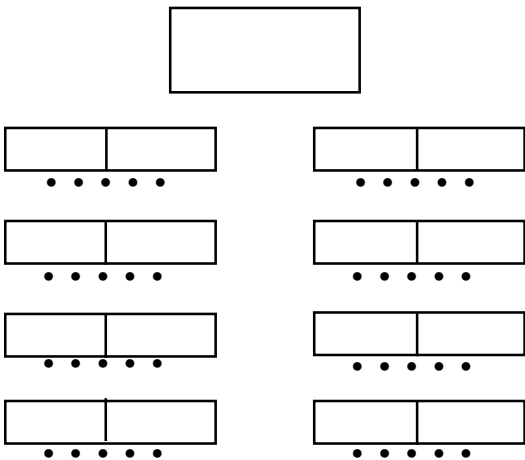

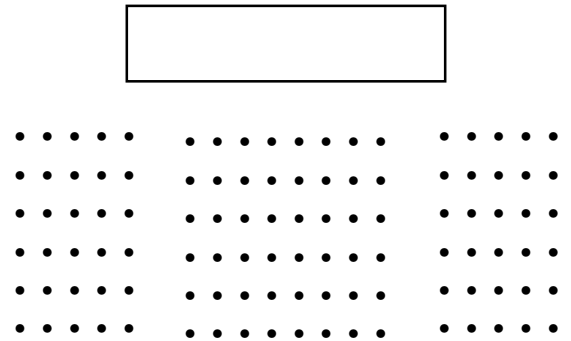

Classroom Style
4

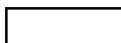

Theater Style
1

Please use these figures to identify:

- Table 
- Podium 
- Chair 